

# **Integrated Process and Fixture Planning System**

**Dr. Michael Stampfer, Attila Rétfalvi**

stampfer@vts.su.ac.yu, ratosz@vts.su.ac.yu

*Abstract: In this paper we give an overview of typical tasks we have to solve during process planning at prismatic parts, presentation of a method for sorting out adequate locating and clamping surfaces on workpiece, and an outline of an integrated process and fixture planning system. And we outline the possibilities of the integration of this planning system with a fixture design system.*

*Keywords: Process planning, Fixture Planning, Fixture Design System*

## **1 Introduction**

With mindful and proper planning we can save substantial money at batch and especially at mass production. Since in the course of process planning there are frequently recurrent actions, the use of computer and adequate algorithms can spare us respective time.

Since the steps of process planning are so much interconnected, only an integrated process planning system can work effectively, where the inputs of a subsystem are the outputs of the appropriate subsystems, and the possibility of recursion is ensured.

## **2 Computer Aided Process Planning**

Two very important parameters, which have to be taken into consideration at process planning, are the material and the amount of the workpiece. In the possession of these data and the detail design drawing of the product (with all dimensions, tolerances and demanded surface qualities) the process engineer has to go through the following – or very similar - steps, which are given for process planning in case of a machined prismatic part.

Plan of setup sequence

Assigning appropriate production methods to each surface

Choosing best technology for producing the balk piece

Determining dimensions of the raw workpiece

Selection of locating surfaces

Selection of machining tools and fixtures

Defining the scope of each setups

Determining the setup sequence

Plan of setups

Breaking up the setups on manufacturing steps

Determination of the contents and the sequence of each manufacturing steps

Tool selection

Plan of manufacturing steps

Tool tracks

Cutting data

Post processing

If we have appropriate data bases such as material-process table, shape-process selection table, feature-process selection table, quantity-process table, tolerance-process table, surface quality-process table, dimension range-process table, list of available manufacturing resources, and a method for estimating manufacturing costs we can write an algorithm for sorting out the appropriate production methods to each surface and for choosing the primary production method [1]. Knowing primary technology, production methods of each surfaces, expected shape and alignment tolerances and surface qualities we can determine the number of manufacturing passes and allowances for each passes for each surfaces - if we have a database which contains preferable allowances and the potentials (accuracy, maximal cutting depth) of roughings and finishings of different production methods. Of course these databases should be refreshed from time to time, complemented with technical characteristics of the new production processes.

It would be even more effective if we had such a system, which is able to learn.

### 3 Fixture Planning

When all these tasks are solved, the next step is the selection of locating surfaces. There are 3 kinds of locating surfaces: supporting (should be the biggest possible), guiding (should be the longest possible) and end support (the smallest possible).

Due to high versatility of workpieces we focus only on those prismatic parts, which are to be machined on horizontal machining centers. The major characteristics of horizontal machining centers are capability of performing different manufacturing operations, tool magazine, they are equipped with rotary table so four sides of a workpiece can be machined in one setup. So depending on the complexity of the workpiece the complete machining can be done in one or maximum in two setups. Commonly these machines are provided with pallet exchanger.

Considering technological facilities of horizontal machining centers and analyzing existing clamping fixtures, according to the position of the supporting surface of the workpiece, there are 3 types of supporting established (*Fig. 1*): (1) Horizontal (denoted with 'pos1'), (2) Vertical ('pos2'), (3) Vertical with ability of partial machining of the locating face ('pos3').

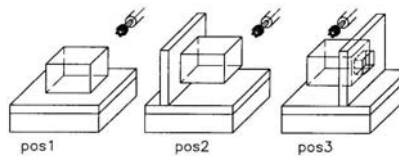

Figure 1  
Plane locating types

There are 4 types of side locating (guiding) established (*Fig. 2*): (1) side locating with the help of surfaces adjoining to the supporting face, (2) side locating with the use of two inside diameters on the supporting face, (3) side locating with utilization of one inside diameter laying on the supporting face and one face adjacent to the supporting face, (4) side locating with application of two threaded joints on the supporting face.









Type	Description	Sub-types			
p1	Locating by using surfaces which are on the adjoining faces of the plane locating face	 p1	 p1	 p1	
p2	Locating by using two inside diameter on the plane locating face	 p21	 p22	 p23	 p24
p3	Locating by using one inside diameter on the plane locating face and a surface on one of the adjoining faces	 p3			
p4	Locating by using two threaded joints on the plane locating face	 p4			

Figure 2  
Types of side locating

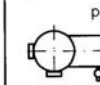
On the base of clamping force direction we can distinguish (*Fig. 3*) perpendicular clamping (s1) – clamping force perpendicular to the supporting surface - and parallel clamping (s2) – clamping force parallel with the supporting surface. The basic type s1, depending on location of clamping faces, can be further divided into subtypes s11, s12 and s13. In the case of s11 the clamping surfaces are the closest parallel faces to the plane locating (supporting) surface. In the case of s12 the clamping surface(s) is on the opposite side of the plane locating face. By s13 the clamping is carried out using a trough hole on the workpiece.

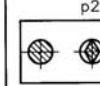
One special way of clamping is clamping by screws and joints on the plane locating face (s3). In this case the clamping forces are acting perpendicular, but the force transmission happens in different way.

The number of clamping points is also a very important characteristic of a clamping. We distinguish clamping in one, two, three or four points. If we supplement the previous basic types with this information, we get that the possible clamping types are: s11\_2, s11\_3, s11\_4; s12\_2, s12\_3, s12\_4; s13\_1, s13\_2; s2\_1, s2\_2; s3\_2, s3\_3, s3\_4. In the enumerated notation the last number means the number of clamping points.



Type	Description of clamping type	Sub-types		
s1	Clamping perpendicular to the plane locating face 	 s11 Clamping on the adjoining faces	 s12 Clamping on the opposite face	 s13 Clamping on the through hole
s2	Clamping parallel to the plane locating face 	 s2		
s3	Clamping by screws and threaded joints on the plane locating face 			

Figure 3  
Types of clamping

## 4 Suitable Surfaces for Locating and Clamping

### 4.1 Suitability for Plane Locating

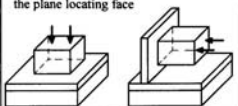
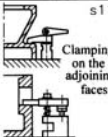
The suitability of a surface for plane locating depends on the shape and size of the surface.

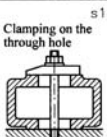
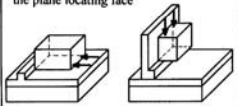
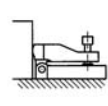
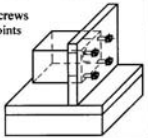
The best surfaces for plane locating are planar surfaces, then intermittent planar surfaces, surfaces on different parallel planes, cylindrical surfaces, and then combined cylindrical and planar surfaces.

We have to choose the biggest possible surface for supporting the workpiece. The minimal allowed size of supporting surfaces is given percentually [3].

### 4.2 Suitability for Side Locating

- a) *Suitability for side locating type p1*: Side locating can be divided into guiding and end supporting.

Suitability for guiding must be tested from 3 aspects, i.e. shape, size and position of the surface.

- According to the shape of the guide locating element the useable faces are: planar face, two planar faces, two cylindrical faces, combination of cylindrical and planar surfaces, and single cylindrical surface.
- The typical dimension of a guiding surface must not be less than 35% of the longest dimension of the plane locating face.
- According to the position of the guiding element they must belong to adjoining faces of the plane locating face.

Suitability for end supporting must be tested from two aspects, i.e. the shape and position of the surface.

- According to the shape of the surface planar or cylindrical surfaces can be applied.
- According to the position they must be on a face, which is adjacent to both locating and guiding faces.

*b) Suitable surfaces for side locating type p2*

According to the shape of surface there should be two holes on the plane locating face. The distance between the holes must not be less than 35% of the greatest length of the plane locating face.

Suitable surfaces for other side locating types are defined in similar way.

### **4.3 Suitability for Clamping**

The following principles must be kept in mind during selection of clamping surfaces:

- The awaking forces should push the workpiece to the fixture.
- In the sake of rigid clamping we have to minimize the moments acting on workpiece
- The clamping should ensure positive rigidity
- The clamping force must not deform the workpiece
- The greatest shear force should be transmitted in formclose way

The clamping devices can be divided into two groups:

- I the clamping force changes with the deformation of the workpiece or the clamping device (screws, cams, wedges, springs, etc)
- II the clamping force is constant (hydraulic, pneumatic, magnetic, etc)

Of course the constant clamping force is better, but we can achieve it only with more expensive devices. So if the variation of clamping force is not too significant, we prefer elements from the first group.

Exactly which device will be used depends on the shape, size and location of surfaces eligible for clamping [6].

For s1.1 eligible are flat surfaces, through holes, pockets; for s1.2 flat surfaces, intermittent planes, cylindrical surfaces; for s1.3 flat ring like surfaces, flat frame like surfaces, group of cylindrical surfaces (with axes parallel to supporting plane); for s2 flat surfaces, intermittent planes; for s3 threaded holes.

The location of clamping surfaces are on the opposite side to the supporting face at s1.1, s1.2 and s1.3, and at s1.3 the center of the hole is approximately coincident with the center of the supporting surface; at s2 there are flat faces opposite to the locating side, and they are near the supporting surface; at s3 there are threaded holes on the supporting surface and the distance between them is great enough (bigger than 40% of the height).

The size of locating face should be big enough to ensure the settlement of clamping devices, and to ensure appropriate clamping pressure. At s3 is needed M6, or greater thread.

Except these – of course – must be controlled if any of the above mentioned principle is violated.

## **5 The Necessary Inputs for the Set-up and Fixture Planning**

It seems that the feature based workpiece model is unavoidable by the technological process planning. However for the conceptual design of fixtures, the workpiece model must contain besides the local data of features, the global structure of workpiece and must be given the possibility of the description of relationships between features as locating tolerances and dimensional tolerances. This problem is solved in a way, that the whole workpiece is first reduced to six faces (top, bottom, left, right, front, back), to each face a plane is designated, the position of those planes are allocated with the distance to workpiece zero point. Each feature has a reference point, in that way each feature position is defined to the workpiece zero point (and hereby also to each other). Very important parts of the workpiece model are the dimension tolerances and locating tolerances of the features themselves [3].

## 6 Setup and Fixture Planning

Most researchers divide the fixture planning process into several steps: (1) Setup planning, (2) Conceptual design of fixture, (3) Fixture configuration [2].

In our opinion the setup planning and the conceptual design of a fixture are so interconnected that the practical planning tasks can not be decomposed to separate fixture and setup planning tasks. The new method makes possible the integrated handling of tasks of setup and fixture planning, and solution searching in an integrated system.

By the workpiece orientation in the workspace of the machine tool and by the reduction of the technological process into set-ups, we suppose that the machining is going to be executed on horizontal machining center. On horizontal machining centers in one setup - in best case - four sides of a prismatic workpiece are machinable. Since one prismatic workpiece has six faces, so it is always machinable in utmost two set-ups. The question is which faces must be machined in one setup, or to put it on other way around, how to select the workpiece position in the workspace of machine tool? These questions can be answered only when the accuracy requirements of the workpiece are analyzed. It is easy to understand that the easiest way to the realization of the prescribed tolerances is machining in one setup the features, which are interconnected with tolerance. The tolerances, which 'interconnect' features, can be divided into loose and strict tolerance connections [3].

The group of loose tolerance connections consists of accuracy-related requirements, which can be achieved relatively easily, even in cases when the connected surfaces are machined in two separate clampings.

The group of strict tolerance connections consists of accuracy-related requirements, which can be achieved with difficulty in cases, when the connected surfaces are machined in two separate clampings, only with the help of highly accurate fixture. Surfaces connected with these connection types must be machined in one clamping. Such surfaces are machined in two separate clampings, only when there is no other solution.

These attributes are extended also to the workpiece faces, so the faces of a workpiece, which contain strictly connected features, are **strictly connected-**, and faces which contain loosely connected features are **loosely connected faces**.

The definition of the workpiece position in the workspace of a machine tool and the setup definition must be done with respect to the location of the functional (connected) features in the structure of workpiece. However, the workpiece position selected in this way can be accepted only when it is suitable for fixture solution (namely suitable for supporting, locating and clamping). This fact necessitates the integrated approach of setup planning and the conceptual design of fixture.



The setup i.e. clamping, in which the functional surfaces, or most of them, are machined is denoted by main clamping, while the setup in which the rest of the surfaces are machined is called additional clamping. Regardless of the clamping sequence, it is the main clamping, which is solved prior to the additional clamping.

Based on the above statements and restrictions the setup and fixture solution consists of main clamping and additional clamping solution.

## **7 General Solution Concept of Main Clamping Fixture and Operation Sequence**

When solving the main clamping one must try to find a position of workpiece in the workspace of machining center in which the machining of all connected faces is possible. In this way we can reach great accuracy of the workpiece and, at the same time, the accuracy requirements and the complexity of the fixture are the smallest. This position of workpiece is denoted as ‘technologically ideal workpiece position’. Fixtures constructed for such cases are the best possible fixture solutions [2]. However in a several cases the disposition of connected faces is such that the workpiece can not be held in a technologically ideal workpiece position. In this case one intends to find a position of the workpieces in which at least the machining of strictly connected faces is possible in one clamping. In other words the loosely connected faces in this stage are left out of consideration. This way the fixture solution is still “fair”, and there are accuracy requirements only toward to the parallelism or to the perpendicularity of some fixture surfaces.

If this attempt is not successful, then one must give up the idea of machining all of the strictly connected faces in one clamping. But there are cases when not the entire face, but the strictly connected features (holes) on the face are workable in one clamping with other strictly connected faces (see 6.3 point).

Lastly, when none of enumerated attempts is successful, one is forced to machine the strictly tolerance related features in separate clamping. In this case the accuracy requirements of the fixture are very high.

Taking into consideration the above-mentioned aspects, four strategies are devised for solving the main clamping:

- Fixture solution for technologically ideal position of the workpiece
- Fixture solution based on the overlook of the loosely tolerance-related faces
- Fixture solution based on the reduction of a strictly tolerance-related side into loosely tolerance-related surfaces and strictly tolerance-related surfaces
- Fixture solution by disintegration of strict functional relationships

The strategies so far declared do not yield equally good solutions for a fixture. Best results are obtained by applying the first strategy. The second strategy is applied only in cases when the first strategy fails to produce solution, etc.

### 7.1 Main Clamping Fixture Solution for Technologically Ideal Position of the Workpiece

This strategy is aimed at finding such a workpiece position in the machine workspace, which would allow machining of all connected faces in one clamping. The potential positions are determined from the requisite that all connected faces should be machined in one clamping. Depending on the plane locating type, this can be formulated in the following manner:

- in the case of horizontal plane locating type - pos1, the plane locating face and its opposite face must not be tolerance-related faces, because it is not possible to machine them together with other faces in the same clamping.
- for a vertical plane locating type - pos2, the plane locating face, the face which is facing the machine table and its opposite face, must not be tolerance-related faces [2], [3].

Since the horizontal plane locating (pos. 1) allows machining of four faces and the fixture construction is simpler, the system first attempts to generate fixture solution for horizontal plane locating type. If that attempt fails, a second attempt is made at solving fixture for vertical plane locating type.

In order to finally adopt the selected workpiece position, it should be suitable for workpiece holding solution. A certain position of workpiece is suitable when it is easy for plane and side locating as well as for clamping.

The selected workpiece position is **suitable for plane locating** if the plane locating face contains surfaces, which are suitable for plane locating. When in the analyzed workpiece position there is no appropriate feature for plane locating, then this position is unfeasible for fixture solution and in this case one must select a new workpiece position. If the workpiece position is suitable for plane locating, then in the next step a check up of suitability for side locating is performed.

The selected workpiece position is **suitable for side locating** if for some of the possible types of side locating there are suitable surfaces on the appropriate workpiece face. In the next step the suitability for clamping is checked.

If, for some of the possible types of clamping, there are suitable surfaces on the appropriate workpiece face (or faces), then the supposed workpiece position is considered to be **suitable for clamping**. Since suitability for plane locating and side locating has already been checked for at the previous stages, the fixture solution has been reached is technologically ideal workpiece position. If the supposed workpiece position is not suitable for clamping, the position is

eliminated and a new position is selected which is again checked for plane locating-, side locating- and clamping suitability.

Considering that the workpiece is six-sided and that, in principle, any face can be chosen for plane locating, the workpiece has six possible positions in the machine workspace for each of the plane locating types pos1 and pos2. If none of the possible workpiece positions meet the discussed requirements, the fixture solution strategy based on the ideal workpiece position cannot yield result, and should be abandoned.

## **7.2 Fixture Solution Based on the Overlook of the Loosely Tolerance-related Faces**

When the first strategy - namely the expectation that all connected faces must be machined in one setup - fails to produce fixture solution, one is forced to lessen this requirement, and by now, we are contented with a workpiece position wherein machining of all strictly tolerance-related faces in one setup is possible. This strategy is similar to the previous one, with the exception that the loosely tolerance-related faces are omitted during the process of selection of workpiece position in the machine workspace.

This can be formulated in the following manner:

- in the case of horizontal plane locating type: the plane locating face and its opposite face must not be strictly connected faces
- for a vertical plane locating: the plane locating face, the face which is facing the machine table and its opposite face must not be strictly connected faces.

In order for the assumed workpiece position to be adopted, in accordance with the previous requirement, it has to be suitable for plane locating, side locating and clamping. With this strategy main clamping is always the second one, which implies that only finished surfaces can be used for locating. Suitability of a workpiece position is checked in similar manner, as with the first strategy.

## **7.3 Fixture Solution Based on the Reduction of a Strictly Tolerance-related Side into Loosely Tolerance-related Surfaces and Strictly Tolerance-related Surfaces**

This strategy is resorted to in cases when the first two strategies fail. The main point of this strategy is to find such a fixture solution, which ensures the machining of all strictly connected surfaces in one setup. It employs the analysis of strictly tolerance-related faces in order to find such a face, which besides strictly tolerance-related holes also contains tolerance-unrelated or loosely tolerance-related faces, which are suitable for locating and clamping. If such face

exists, then all the included surfaces, except the strictly tolerance-related ones, are machined in additional clamping. That face will be the plane locating face in the main clamping (in which all the strictly tolerance-related workpiece surfaces, including these on the plane locating face, will be machined). Since in this case some surfaces on the plane locating face are machined, the plane locating type is always vertical with partial machining of the locating face ('pos3'). More precise definition of workpiece position follows from the condition that the face facing the machine table and its opposite face must not be strictly tolerance-related. This fixture solution allows machining accuracy without special requirements in respect to fixture accuracy but nevertheless increases fixture complexity. The example fixture presented on the Fig. 4 is designed by using this strategy.

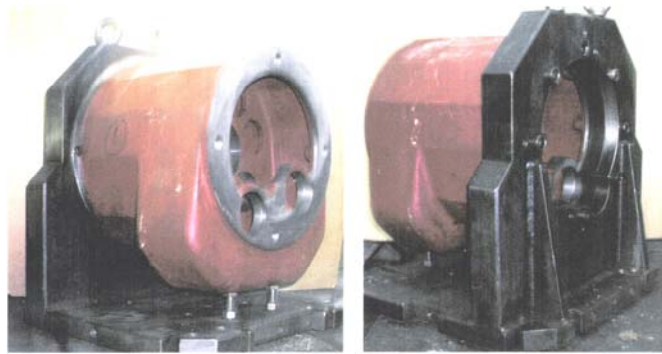

Figure 4

Machining of high accuracy holes through the opening in the fixture body

#### 7.4 Fixture Solution by Disintegration of Strict Functional Relationships

Should none of the discussed strategies succeed in generating the desired solution, one is forced to resort to machining the strictly tolerance-related surfaces in separate clampings. For this reason, the fixture for second clamping must be made with high precision, which often presents a key issue in meeting workpiece accuracy demands. By now one needs to analyze only the workpiece positions, where the plane locating face is one of the strictly connected faces. Namely the other possible positions of the workpiece are already analyzed through the application of the first three strategies, but no solution is found. The first step involves an attempt to find by horizontal plane locating such workpiece position in the machine workspace, which ensures that the face opposite the plane locating face is not strictly tolerance-related. If this attempt fails, then both the plane locating face and its opposite face are allowed to be strictly tolerance-related. The selection of type of side locating must be done with special attention, performed on the basis of the type of strict face connection [2], [3].

## 7.5 Definition of the Content of Set-ups

Upon solving the main clamping fixture it transpires the following facts: plane locating type, plane locating face of the workpiece in main clamping, plane locating surfaces, side locating type, guiding- and endsupporting surface, clamping type and clamping surfaces. Based on these facts it is possible to reduce technological operations to main and additional clamping. It is to be defined which features are machined in main clamping and which in additional clamping. This task can be relatively easy when the plane locating type in main clamping is horizontal or vertical. In these cases is sufficient to define the faces (and certainly all features which belong to some face), which will be machined in the main clamping, or rather in the additional clamping. When the plane locating type is vertical with partial machining of the plane locating face, then reduction of technological operation to main and additional clamping presents a more complex task due to the fact that the main clamping plane locating face has to be partially machined in both main and additional clamping. For this reason, it should be precisely defined which surfaces on the plane locating face should be machined in the main clamping and which should be machined in the additional clamping (Fig. 5).

Sequentially ordered, with the exception of one case, the additional clamping takes precedence. The main clamping takes precedence in that case when the fixture solution is done in a technologically ideal workpiece position but in this position the workpiece has only rough surfaces suitable for plane locating.

Plane locating type in the main clamping	Machining in the main clamping	Machining in the additional clamping
 <b>Horizontal</b>	Four faces	The plane locating face in the main clamping and its opposite face
 <b>Vertical</b>	Three faces	The plane locating face in the main clamping, the face facing the machine table and its opposite face.
 <b>Vertical with partial machining of the locating face</b>	Three whole faces and the strictly connected holes on the plane locating face	The face facing the machine table and its opposite face as well the partial plane locating face in the main clamping

Figure 5

Reduction of technological operation into clampings

## 8 Integration

As input to the system serve the quantity, the material and the detail design drawing of the workpiece, available technologies, machines and tools. Thanks to the fast development, which can be experienced in the area of CAD and CAM systems, nowadays already in the majority of firms these data are stored on computers. Moreover the data of workpieces are approachable not only in 2D, but also in form of 3D computer model (CAD model). The 3D model is commonly used as input data at writing CNC program, but an existing 3D model can be equally well used at fixture planning.

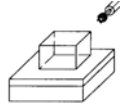
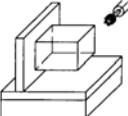
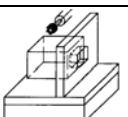
The above mentioned setup planning system complemented with a feature and tolerance recognizer module can significantly ease down and speed up the process planning, moreover enable automation of fixture planning in the case of prismatic parts. So far the described system works manually, what means that, in defining all necessary data for the feature description the process engineer is involved. The system defines set ups, determines set up sequence, gives conceptual solution of workpiece holding. These outcoming data are used for operation planning, and as well at fixture designing.

Operation planning includes the reduction of technological operations to particular cuts, choosing appropriate tools for different cuts and selection optimal cutting data. Due to non linearity of this task, the huge number of solutions – among them there are vast number of such solutions, which are far from optimal –, the complex interconnection between data and difficult estimation of sub solutions it is advised use of genetic approach, beside variant and generative approach [4].

For fixture design, above the data provided by described system, a database of existing fixtures, fixture elements, selection rules and an evaluation method are needed.

In the possession of CAD models of all fixture elements (more and more manufacturer provide them) we can visualize our fixture, and by exploitation of tool path visualizer and interference checker ability of CAD/CAM systems, we can instantly check our solution.

Since all these data are complexly interconnected, only an integrated Process and Fixture Planning System combined with Fixture Design System can effectively work. In order to work really efficient, the system must be provided with multiple step back ability.

Figure 6 shows the schema of an integrated Process and Fixture Planning System.

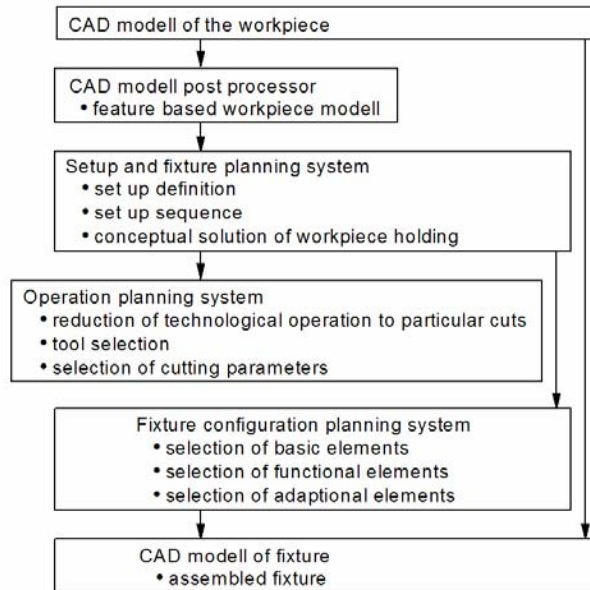

Figure 6  
Integrated Process Planning and Fixture Planning System

**Conclusion**

The ultimate goal of computer integrated manufacturing (CIM) and concurrent engineering is to integrate design, manufacturing, shop floor activities and management activities [5]. As part of it, there is a big demand for such a system, which, on the base of available technologies, machines, tools, the quantity, material and CAD model of desired part, without (or with minimal) interference of process engineer can choose technologies, give us optimal set up order, operation sequence, choose tools and optimal cutting data, devise fixtures and even with assistance of robots builds fixtures.

Our goal is to contribute to bringing it into being, by creating sub system for fixture design, which can – by using output data from already existing setup planning system [3] – select proper functional, basic and adapting elements of a modular element set, and make the 3D model of the fixture.

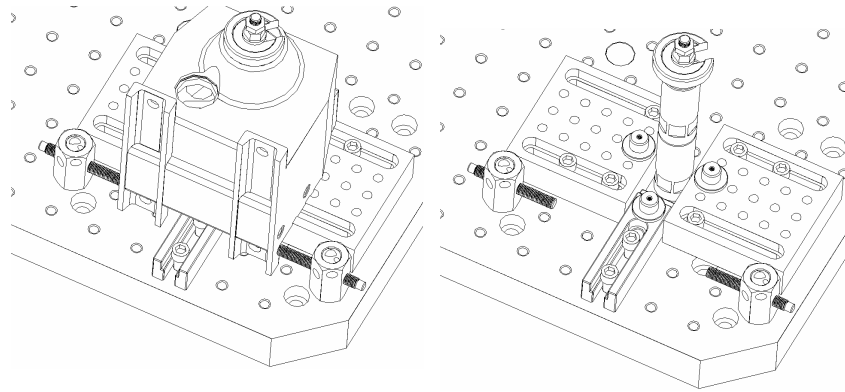

Figure 7

CAD model of a fixture, built from modular elements

left) with the workpiece

right) without the workpiece

#### References

- [1] Shaw C. Feng, Y. Zhang: Conceptual Process Planning – A Definition and Functional Decomposition, Manufacturing Engineering Laboratory - National Institute of Standards and Technology
- [2] M. Stampfer: Integrated setup and fixture planning system for gearbox casings, *Int J. of Advanced Manufacturing Technology*, 2004, pp. 310-318
- [3] M. Stampfer: Számítógéppel segített műveleti sorrend- és befogás tervezés vízszintes főorsójú megmunkáló központok esetére (különös tekintettel a szekrényes alkatrészekre), PhD disszertáció, 2005
- [4] J. Váncza: Műveleti sorrendtervezés tudásalapú módszerek és genetikus algoritmusok együttes alkalmazásával, Kandidátusi értekezés, 1993
- [5] M. Sadih, D. R. Yadav, P. V. Mohanram, P. Radhakrishan: A Generative Computer Aided Process Planning System for Prismatic Components, *Int. J. of Advanced Manufacturing Technology*, 2002, pp. 709-719
- [6] Kyoung Hung Kim: A System for Automated Fixture Planning with Modular Fixtures, PhD thesis, 1993